

## Specifications

- Voltage rating: 50V AC, DC
- Current Rating: 1A, AC, DC
- Withstand voltage: 500V AC/minute
- Contact resistance: 30mΩ max
- Insulation resistance: 500MΩ min
- Temperature range: -40°C ~ +105°C
- Compliant with RoHS and REACH
- Contact JVT for details

## Assembly layout

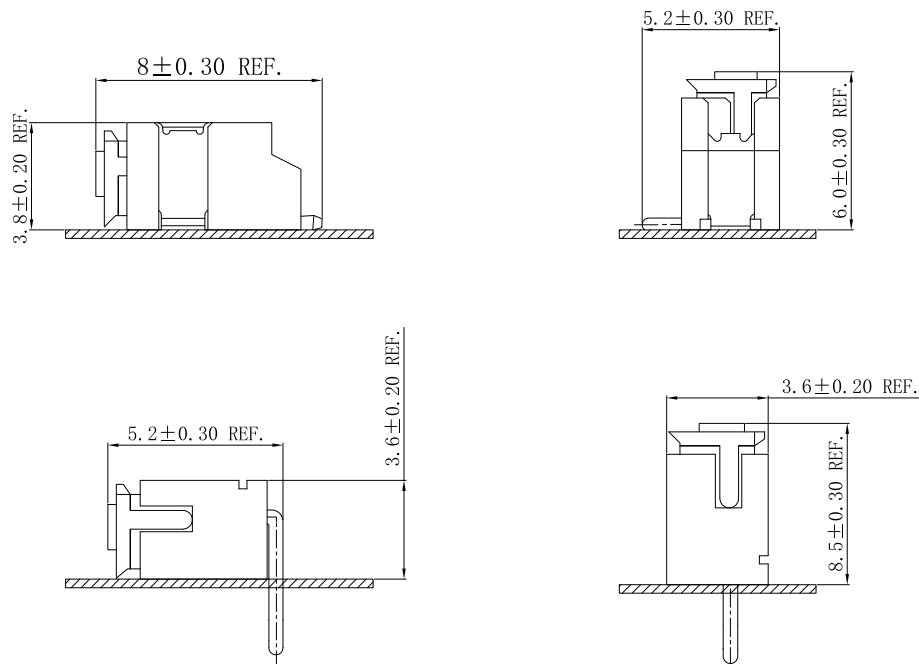

**JVT1173/1174SERIES**

1.5mm pitch wire to board connector

**JVT1173HRH**

1.5mm Pitch housing

HOUSING

Part No. : JVT1173HNO-XXRH

Material: Nylon 66 UL94V-0

Mates With Part(s): JVT1173 Terminal

JVT1173HNO-XXRH  
Logo  
Series NO.  
Housing  
Circular hole  
PIN NO.  
PA66 UL94V-0

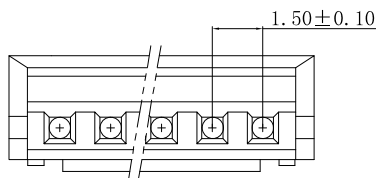
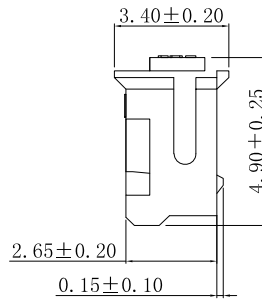
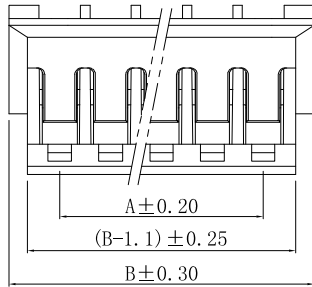
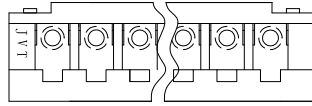

Poles	Dimensions (mm)	
	A	B
02	1.50	4.50
03	3.00	6.00
04	4.50	7.50
05	6.00	9.00
06	7.50	10.50
07	9.00	12.00
08	10.50	13.50
09	12.00	15.00
10	13.50	16.50
11	15.00	18.00
12	16.50	19.50
13	18.00	21.00
14	19.50	22.50
15	21.00	24.00
16	22.50	25.50

Unit:mm

**JVT1173H**

1.5mm Pitch housing

HOUSING

Part No. : JVT1173HNO-XX

Material: Nylon 66 UL94V-0

Mates With Part(s): JVT1173 Terminal

JVT1173HNO-XX  
Logo  
Series NO.  
Housing  
PIN NO.  
PA66 UL94V-0

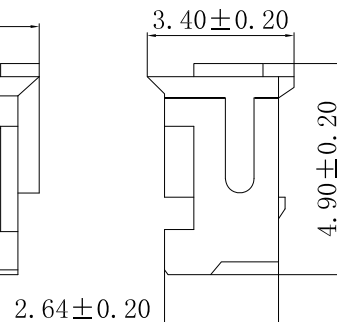
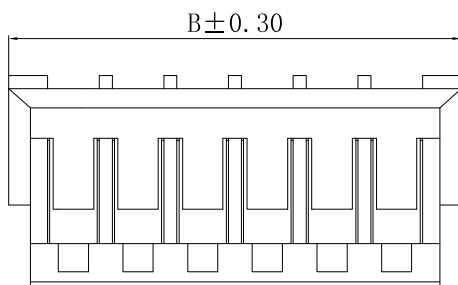
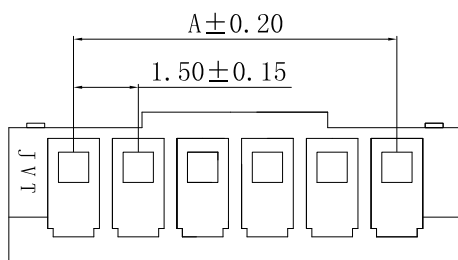

Poles	Dimensions (mm)	
	A	B
02	1.50	4.50
03	3.00	6.00
04	4.50	7.50
05	6.00	9.00
06	7.50	10.50
07	9.00	12.00
08	10.50	13.50
09	12.00	15.00
10	13.50	16.50
11	15.00	18.00
12	16.50	19.50
13	18.00	21.00
14	19.50	22.50
15	21.00	24.00
16	22.50	25.50

Unit:mm

**JVT1173 SERIES**

1.5mm pitch wire to board connector

**JVT1173T** — 1.5mm Pitch Crimp Terminal

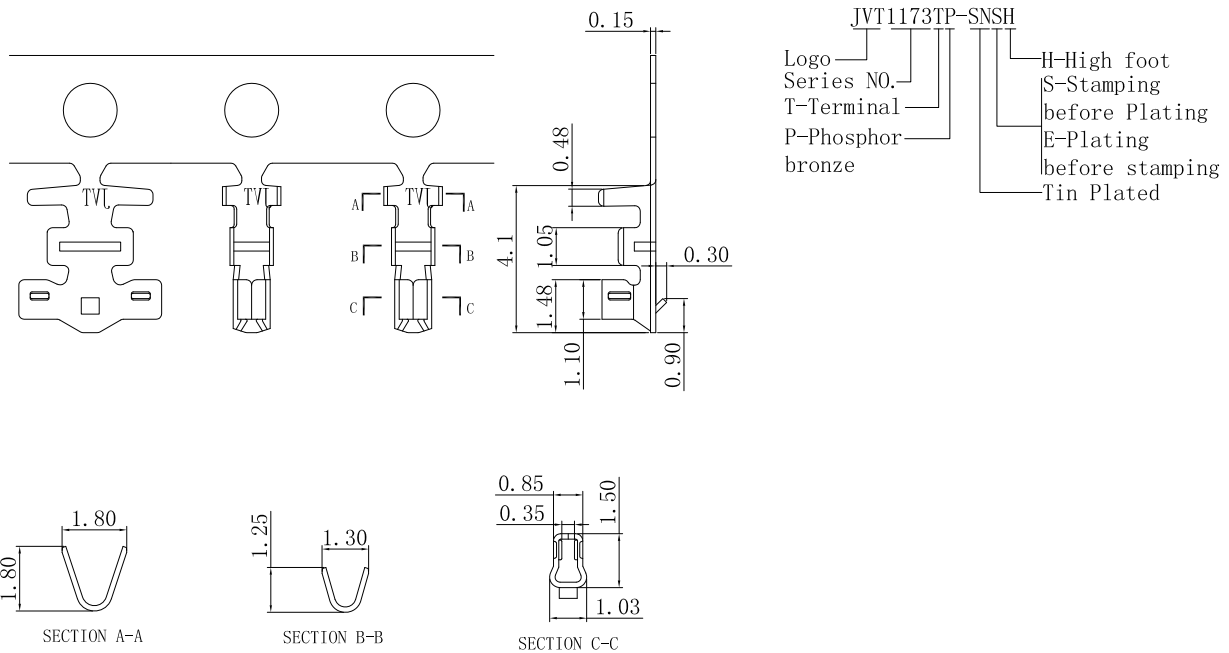

JVT1173TP-SNSH	Phos Bronze	Tin Plated	AWG#26~28	1.10mm(Max)	JVT1173 Housing
PART NO	Material	Finish(Pin)	Wire Range	Insulation O. D.	Mates With Part(s)

**JVT1173T** — 1.5mm Pitch Crimp Terminal

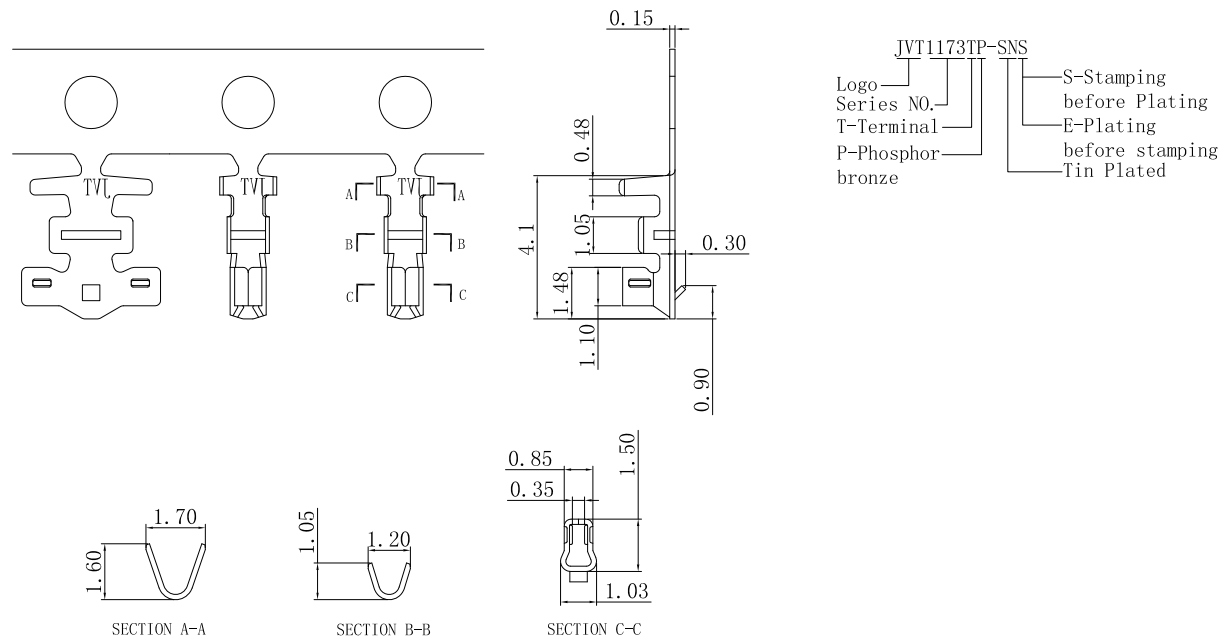

JVT1173TP-SNS	Phos Bronze	Tin Plated	AWG#26~32	1.10mm(Max)	JVT1173 Housing
PART NO	Material	Finish(Pin)	Wire Range	Insulation O. D.	Mates With Part(s)

**JVT1173/1174 SERIES** 1.5mm pitch wire to board connector

**JVT1174W** — 1.5mm Pitch Wafer-SMT TYPE

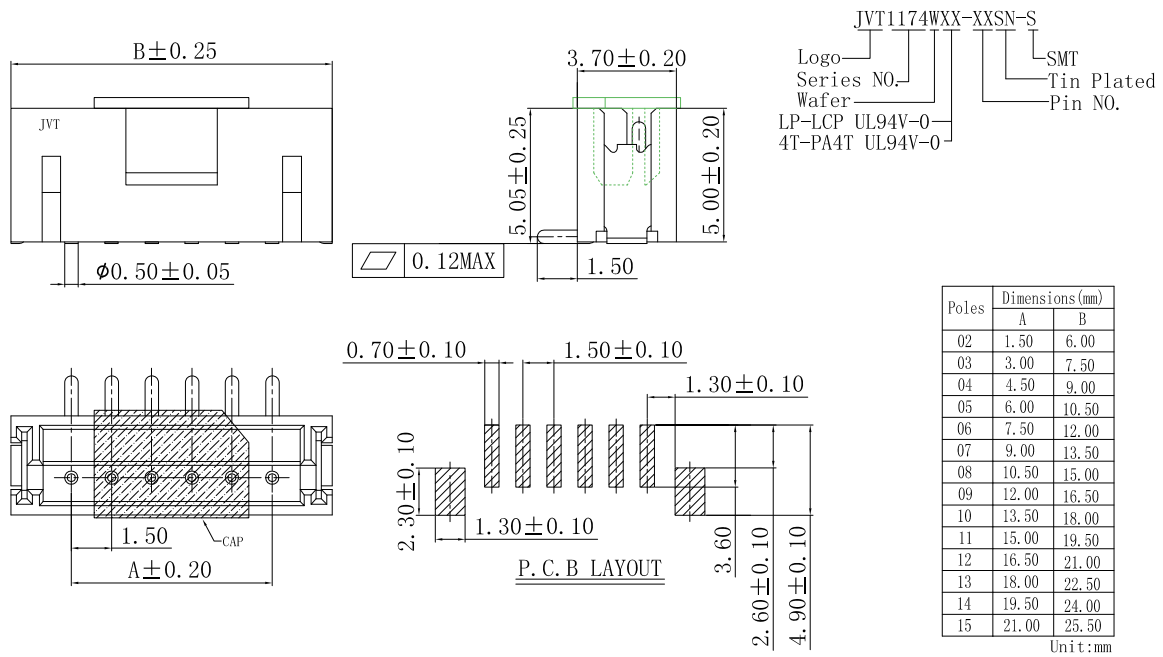

JVT1174WLP-XXSN-S	LCP UL94V-0	Brass	Tin Plated	Phos Bronze	Tin Plated	JVT1173 Housing
JVT1174W4T-XXSN-S	PA4T UL94V-0					
PART NO	Material	Material(Pin)	Finish(Pin)	Material (Solder Tabs)	Finish (Solder Tabs)	Mates With Part(s)

**JVT1174WR** — 1.5mm Pitch 90° Wafer-SMT TYPE

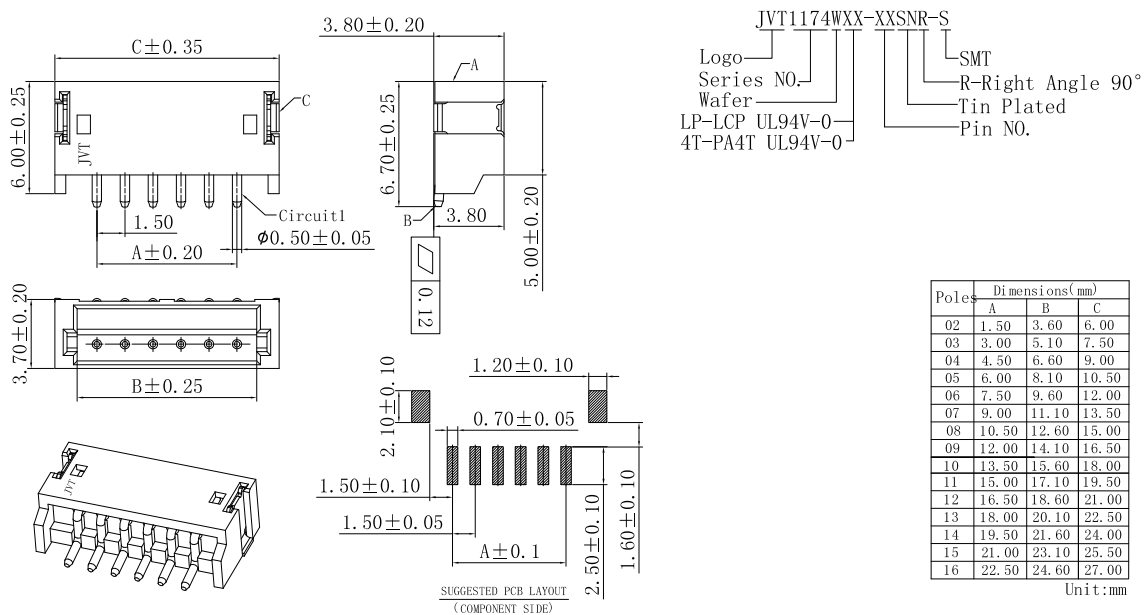

JVT1174WLP-XXSNR-S	LCP UL94V-0	Brass	Tin Plated	Phos Bronze	Tin Plated	JVT1173 Housing
JVT1174W4T-XXSNR-S	PA4T UL94V-0					
PART NO	Material	Material(Pin)	Finish(Pin)	Material (Solder Tabs)	Finish (Solder Tabs)	Mates With Part(s)

**JVT1173/1174 SERIES** 1.5mm pitch wire to board connector

**JVT1174W** — 1.5mm Pitch Wafer-SMT TYPE

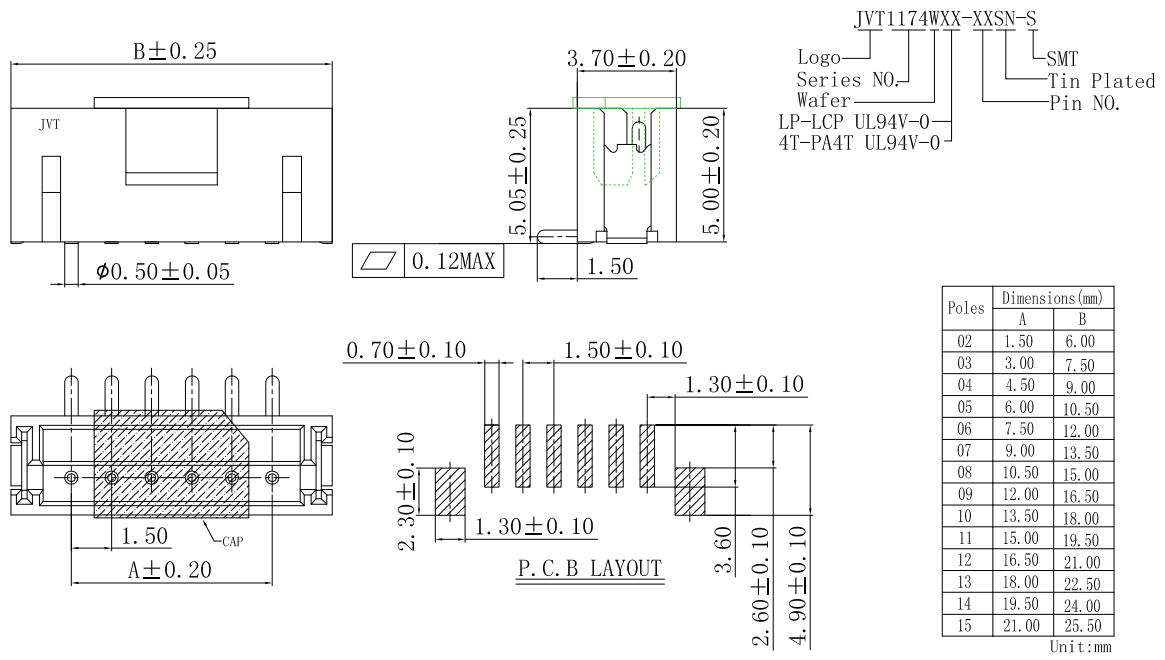

JVT1174WLP-XXSN-S	LCP UL94V-0	Brass	Tin Plated	Phos Bronze	Tin Plated	JVT1173 Housing
JVT1174W4T-XXSN-S	PA4T UL94V-0					
PART NO	Material	Material(Pin)	Finish(Pin)	Material (Solder Tabs)	Finish (Solder Tabs)	Mates With Part(s)

**JVT1174WR** — 1.5mm Pitch 90° Wafer-SMT TYPE

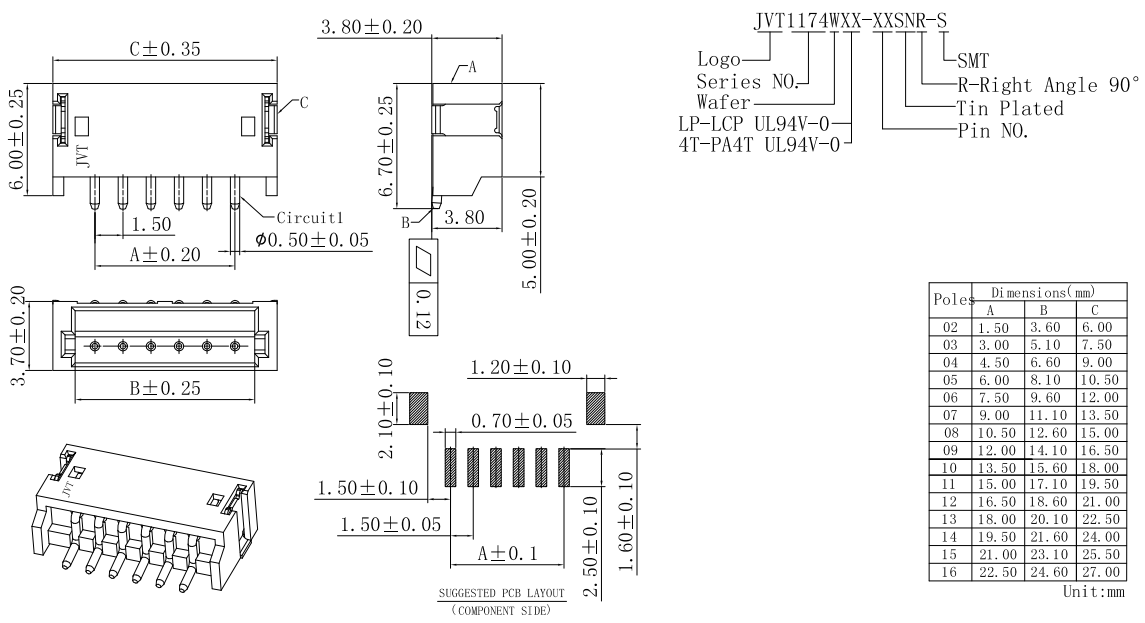

JVT1174WLP-XXSNR-S	LCP UL94V-0	Brass	Tin Plated	Phos Bronze	Tin Plated	JVT1173 Housing
JVT1174W4T-XXSNR-S	PA4T UL94V-0					
PART NO	Material	Material(Pin)	Finish(Pin)	Material (Solder Tabs)	Finish (Solder Tabs)	Mates With Part(s)

**JVT1173/1174 SERIES** 1.5mm pitch wire to board connector

**JVT1174W**

1.5mm Pitch Wafer-DIP TYPE

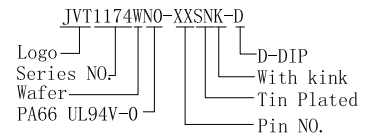
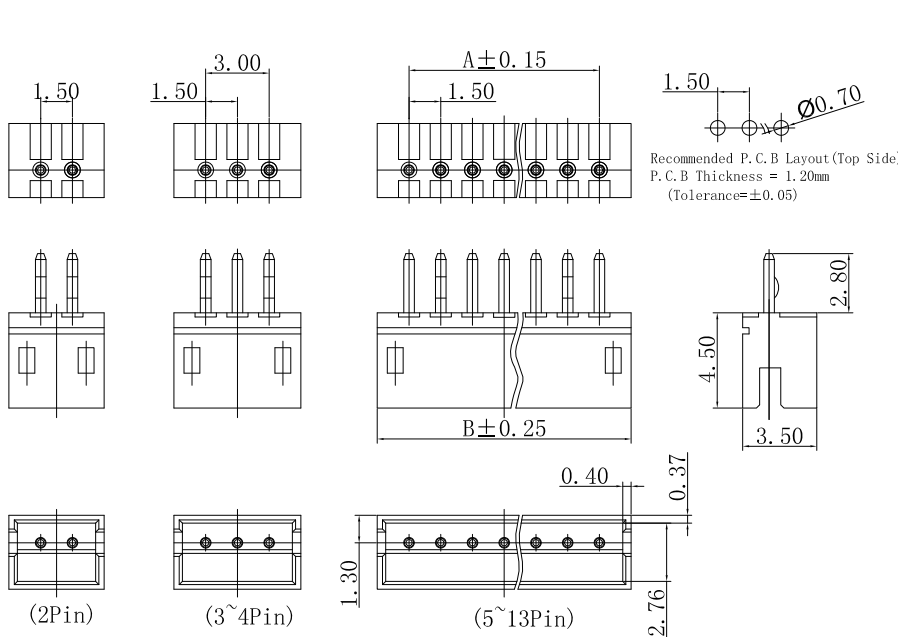

Recommended P.C.B Layout (Top Side)  
P.C.B Thickness = 1.20mm  
(Tolerance=±0.05)

Poles	Dimensions (mm)	
	A	B
02	1.50	4.50
03	3.00	6.00
04	4.50	7.50
05	6.00	9.00
06	7.50	10.50
07	9.00	12.00
08	10.50	13.50
09	12.00	15.00
10	13.50	16.50
11	15.00	18.00
12	16.50	19.50
13	18.00	21.00

Unit:mm

JVT1174WN0-XXSNK-D	PA66 UL94V-0	Brass	Tin Plated	JVT1173 Housing
PART NO	Material	Material(Pin)	Finish(Pin)	Mates With Part(s)

**JVT1174WR**

1.5mm Pitch 90° Wafer-DIP TYPE

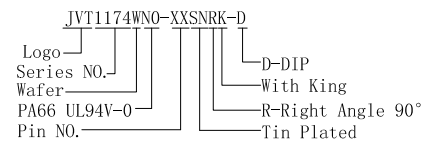
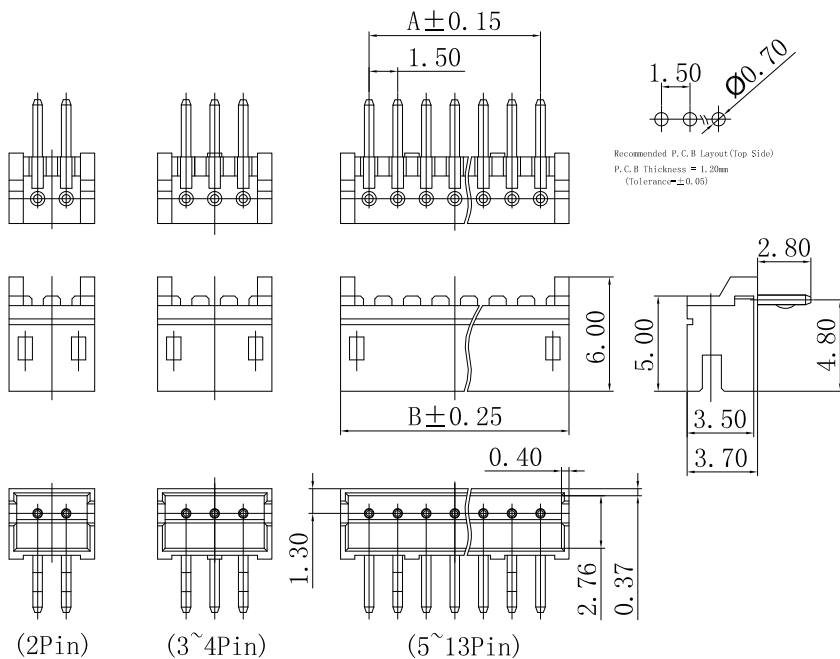

Recommended P.C.B Layout (Top Side)  
P.C.B Thickness = 1.20mm  
(Tolerance=±0.05)

Poles	Dimensions (mm)	
	A	B
02	1.50	4.50
03	3.00	6.00
04	4.50	7.50
05	6.00	9.00
06	7.50	10.50
07	9.00	12.00
08	10.50	13.50
09	12.00	15.00
10	13.50	16.50
11	15.00	18.00
12	16.50	19.50
13	18.00	21.00

Unit:mm

JVT1174WN0-XXSNRK-D	PA66 UL94V-0	Brass	Tin Plated	JVT1173 Housing
PART NO	Material	Material(Pin)	Finish(Pin)	Mates With Part(s)